

---

# **MOSLEY**

# **PRO-96...**

#564128

NINE ELEMENT BEAM COVERING 10, 12, 15, 17, 20, 40

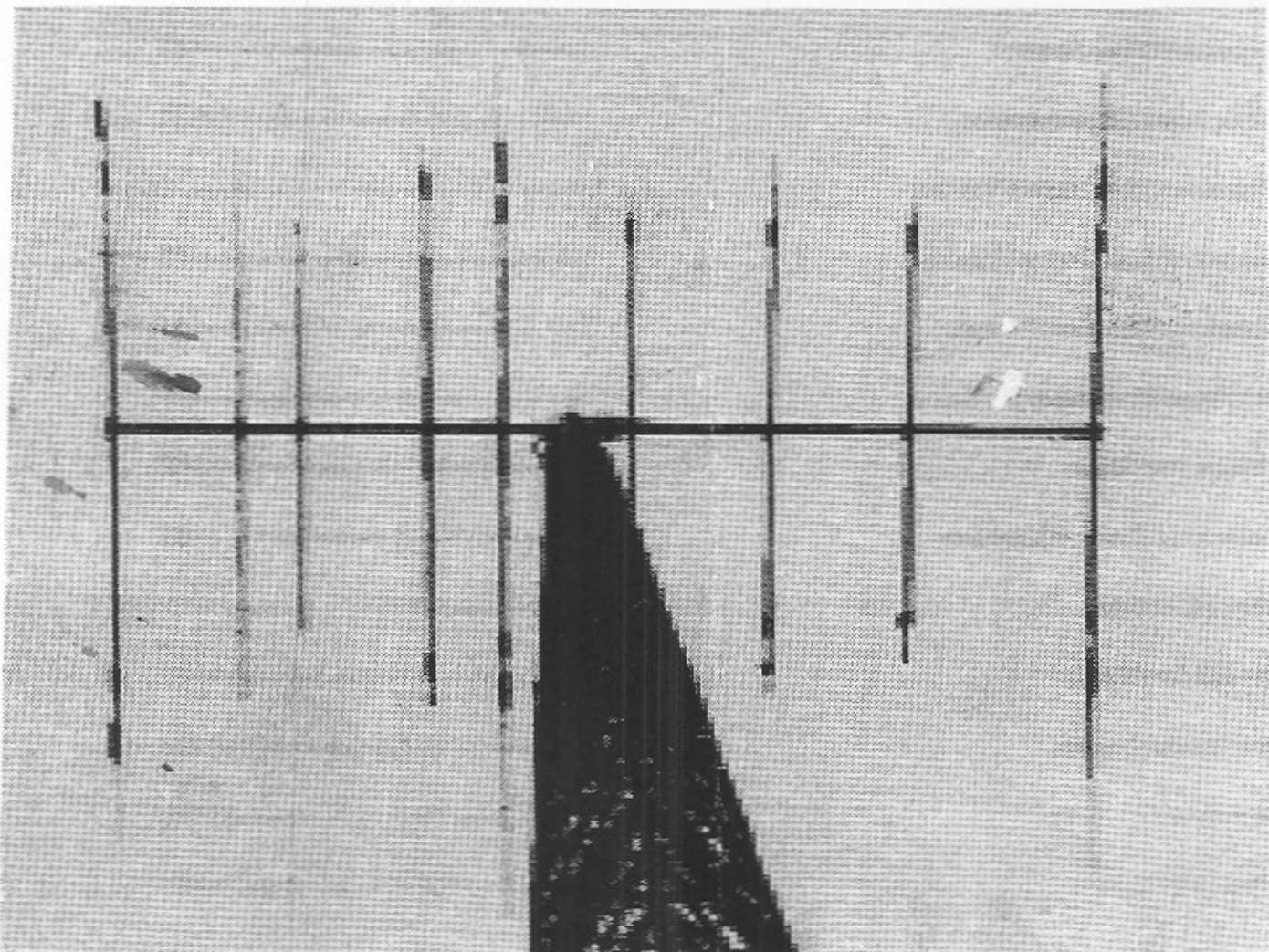

Mosley Electronics, Inc., 10812 Ambassador Boulevard, St. Louis, MO 63132  
Phone 314-994-7872, Fax 314-994-7873

---

**MOSLEY "A BETTER ANTENNA"**

---

---

## Table of Contents

<u>CONTENTS</u>	<u>PAGE #</u>
Parts List	-----3
Deburring and Cautions	-----5
Assembly of Boom	-----6
Assembly of Mast Plate	-----7
Review of Driven Elements	-----8
Assembly of Driven Elements	-----10
Placing Driven Elements to Boom	-----11
Assembly of Large Trapped Parasitics	-----12
Assembly of Small Trapped Elements	-----13
Assembly of Mono Band Elements	-----13
Attaching and Assembling the Strut	-----14
Preparing Your Coax	-----15
Placement of Coax to Phasing Lines	-----15
Using an R.F. Choke	-----16
Dimensions of PRO-96	-----17
Boom Spacing Diagram	-----18
Suggestions	-----19
Typical SWR Curves	-----19

## PRO-96

The high performance of your Mosley PRO-96 can only be achieved if this beam is assembled in accordance with the instructions in this manual. Substitutions of materials or modification of design will greatly lessen its performance.

We recommend that you read through the assembly instructions and familiarize yourself with each step before assembling your antenna.

### HARDWARE FOR 2" BOOM USING 2" MAST

PART NUMBER	QUANTITY	ITEM
1	2	DRIVEN ELEMENT SUPPORT
2	16	DRIVEN ELEMENT INSULATORS
3	48	#10 LOCK WASHERS
4	32	10/32 X 1-1/2" MACH. SCREWS
5	16	10/32 X 1-3/4" MACH. SCREWS
6	4	1-1/8" X .058 X 72" RED/BRN
6A	2	1" X .058 X 48", DBLBRN
6B	2	1" X .058 X 27", DBLRED
7	2	7/8" X .058 X 24", DBLBRN
8	72	#8 X 1/2" S.S. SHEET METAL
9	2	7/8" X .058 X 27" DBL RED
10	2	12" TRAP ASSEMBLY, DBL BRN
11	2	12" TRAP ASSEMBLY, DBL RED
12	2	7/8" X .058 X 8-1/2" DBL BROWN
13	2	5/8" X .035 X 17-1/2" RED
14	2	18" TRAP, COLOR CODED DBLBRN
15		
16	2	5/8" SWAGED TO 3/8" X .058 X 46"
17	6	#6 SHEET METAL SCREW
18		
19	2	3/8" X .049 X 72" END TIP, DBLBRN
20		
21		
22		
23	6	3/8" END CAP
24	10	1-1/2" U-BOLTS, 1/4-20
24A	23	2" U-BOLTS, 5/16-18
24B		
25	9	#48 CLAMPING BLOCK
26	20	5/16 LOCK WASHER
26A	38	3/8 LOCK WASHER
27	20	5/16 NUT
27A	38	3/8 NUT
28	2	PHASING LINES
29		
29A	2	8/32 X 1" SCREW SS
29B	4	#8 LOCK WASHER
29C	4	8/32 NUT
29D		
30	10	#43 CLAMPING BLOCK
30A	10	#47 CLAMPING BLOCK
31	1	MAST PLATE, HVY DUTY
32	1	1-3/8" X .058 X 72", TRIPLE BLUE
33	2	1-1/4" X .058 X 72", TRIPLE BLUE

34	2	1-1/8" X .058 X 20", TRIPLE BLUE
34A	2	1" X .058 X 12, TRIPLE BLUE
34B	2	7/8" X .058 X 11-1/2", TRAP BLUE
35	2	12" TRAP, TRIPLE BLUE
35A	2	7/8" X .058 X 11-1/4", TRAP BLUE
35AA	2	7/8" X .058 X 13-1/4", TRAP BLUE
35B	2	18" TRAP, TRIPLE BLUE
36	2	5/8" X .058 X 46", SWAGED, TRIPLE BLUE
36A	2	3/8" X .049 X 50", TRIPLE BLUE
37	10	5/8" CAPLUG
38	1	1-3/8" X .058 X 72", DBL YELLOW
39	2	1-1/4" X .058 X 72", DBL YELLOW
40	2	1-1/8" X .058 X 26", DBL YELLOW
40A	2	1" X .058 X 26", DBL YELLOW
40B	2	7/8" X .058 X 18", DBL YELLOW
41	2	12" TRAP, DOUBLE YELLOW
41A	2	7/8" X .058 X 10-3/8", DBL YEL
41AA	2	7/8" X .058 X 13-7/8", DBL YEL
41B	2	18" TRAP, DOUBLE YELLOW
42	2	5/8" X .058 X 46" SWAGED, DBL YELLOW
42A	2	3/8" X .049 X 48", DOUBLE YELLOW
43	1	1-1/8" X .058 X 72", DOUBLE WHITE
44	2	1" X .058 X 72", DOUBLE WHITE
45	2	7/8" X .058 X 29", DOUBLE WHITE
45A	2	12" TRAP, DOUBLE WHITE
45B	2	5/8" X .035 X 14", DOUBLE WHITE
46	2	3/4" CAPPLUGS
47	1	1" X .058 X 18", DOUBLE BLACK
48	2	7/8" X .058 X 72", DOUBLE BLACK
49	2	3/4" X .058 X 39", DOUBLE BLACK
50	1	1" X .058 X 18", DOUBLE GREEN
51	2	7/8" X .058 X 72", DOUBLE GREEN
52	2	3/4" X .058 X 42", DOUBLE GREEN
53	2	5/8" X .058 X 39", DOUBLE GREEN
54	1	2", BOOM SECTION
55	1	1.768 X .120 X 144", SPLICE
56	1	2", BOOM SECTION
57	1	1.768 X .120 X 144", SPLICE
58	1	2", BOOM SECTION
59	2	3/8" X 4-1/2", EYEBOLT AND NUT
60	2	3/8" X 4-1/2", EYEBOLT AND NUT
60A	2	3/16", SS AIRCRAFT CABLE
60B	12	3/16", CABLE LOCKS
60C	1	STRUT BLOCK, 3" CHANNEL
60D	1	STRUT PLATE, 3-1/2 X .25 X 18"
60E	1	STRUT MAST, 1-1/2" X .125 X 84"
61	8	1/4" X 2-1/2", BOLT
62	8	1/4", LOCK WASHER
63	8	1/4", NUT
64	2	2" Boom Caps

---

64A	1	1-1/2", STRUT CAP
65	2	1", INNER CAPPLUGS
65A	2	7/8", INNER CAPPLUGS
66	2	#1021, SOLDER LUG
67	1	1-1/8" X .058 X 72", DOUBLE BLUE
68	2	1" X .058 X 72", DOUBLE BLUE
69	2	7/8" X .058 X 29", DOUBLE BLUE
70	2	12" TRAP, DOUBLE BLUE
71	2	5/8" X .035 X 34-1/2", DOUBLE BLUE
72	1	1-1/8" X .058 X 72", TRIPLE WHITE
73	2	1" X .058 X 72", TRIPLE WHITE
74	2	7/8" X .058 X 29", TRIPLE WHITE
75	2	12" TRAP, TRIPLE WHITE
76	2	5/8 X .035 X 14", TRIPLE WHITE
77	1	WARRANTY CARD
78	1	INSTRUCTION MANUAL
79	4	PENATROX
80	1	WARNING NOTICE
81	1	DEBURRING NOTICE

---

### ASSEMBLY

< > Start by grouping all element sections and traps according to color code.

### DEBURRING

< > MAKE SURE that before attempting to sleeve ANY of the pieces of tubing together you check to see that all tubing pieces are DEBURRED!

While building the antenna we have removed the majority of the burrs, however, due to the number of pieces of tubing, the cost of labor and the time consumption some pieces will have burrs.

The tubing Mosley uses is made for us and the sleeving tolerances are very close. If you would try and force a piece of tubing to sleeve, which is not deburred, it will SEIZE. If this would happen you aren't going to get them apart.

Since this is a beautiful beam, we have put a lot of time and pride into it, take a few minutes and check the pieces.

NOTE: Penatrox, an anti-corrosion compound should be applied between coupled sections of tubing to prevent formation of high resistance and seizing of aluminum.

---

**CAUTIONS**

< > In an attempt to keep the weight of the antenna down to a minimum, we are using a .035 wall on the small, single end tips. In their area of use they, are as strong as a heavier walled piece. However, WHEN SECURING WITH THE #8 STAINLESS SHEET METAL SCREW, DON'T OVER TIGHTEN! Seat the screw flush with the tubing and stop.

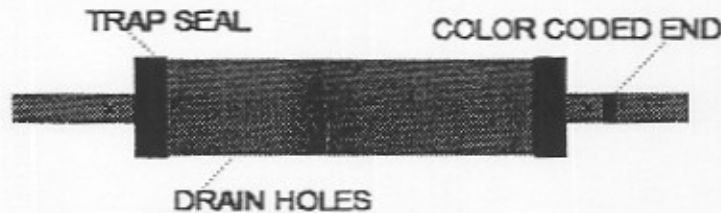

< > CAUTION: TRAP ASSEMBLIES ARE COLOR-CODED..... THIS COLOR-CODE SHOULD ALWAYS GO TOWARD THE BOOM. INSERT TOWARD THE CENTER. REVERSAL OF THE TRAPS WILL CAUSE HIGH S.W.R. AND OTHER MALFUNCTIONS.

< > Mark the color coded ends of the traps by placing masking tape on the metal trap cover and note the side and color on the trap. This will solve any problems if the color code comes off when sanding or placing the penatrox on the trap tubing. THE TRAPS CAN GO INTO THE 7/8" CONNECTING PIECE EITHER WAY.

< > Deburr tubing and use the enclosed PENATROX.

< > Review the drawings and READ the instructions before assembly.

< > Follow all safety procedures in assembly and raising of this beam. Make sure cable locks and hardware are re checked. When installing the antenna, make sure the tower and all other associated hardware, assembly personnel and components are rated correctly for this antenna!

**ASSEMBLY OF THE BOOM**

< > The boom is color coded and marked by numbers so that the correct splice will align with the correct section of boom.

< > Start by joining the correct pieces of boom and splice. (Parts 54, 55, 56, 57, 58). Align the holes of the boom and splice and secure with the 1/4"



bolt, lock WASHER and nut. (Parts 61, 62, 63).

< > Once the complete boom is assembled, insert EYEBOLTS into the holes along the boom. MAKE SURE BOTH EYELETS ARE POINTING UP ON SAME SIDE AND ARE IN LINE WITH BOOM.

< > Once boom is assembled correctly tighten all hardware.

### ASSEMBLY AND PLACEMENT OF MAST PLATE

**\*\*Note**

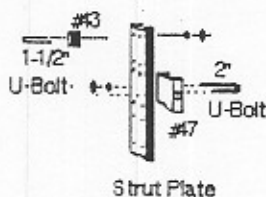

Strut Plate

< > The measurements given in this section for the placement of the STRUT Plate and MAST Plate are only starting dimensions. These distances will get you close to your balance point, however, they will change once the antenna has all the elements in place, so be prepared to make an adjustment to the strut plate and mast plate.

< > Place center of the strut plate 8" from the DOUBLE WHITE director color code, between the FRONT DRIVEN element DOUBLE BROWN color code. (Part 60D)

< > Place a 2" U-Bolt around the boom and place a #47 aluminum clamping block ears over the ends of the 2" U-Bolt. Make sure the curve side of the #47 is to the down side so it will allow the internal radius of the block go around the boom.

< > Place the Smaller STRUT plate and put it onto the 2" U-Bolt. Make sure the plate is mounted vertical to the boom. Refer to pictures.

< > Do the same for the second 2" U-Bolt. Once both clamping blocks and U-Bolts are in place, secure the strut plate by using the 5/16 lock washers and nuts.

< > Place the edge of the LARGE MAST PLATE 5" from the center of the STRUT PLATE. Keep the Mast Plate on the same side of the boom as the strut plate. Keep the Mast Plate in line with the STRUT PLATE, that is, parallel to each other.

**NOTE: BOTH THE STRUT PLATE AND MAST PLATE WILL BE MOVED TO LOCATE THE FINAL BALANCE POINT ONCE THE ANTENNA IS COMPLETELY ASSEMBLED. DO NOT TRIM STRUT CABLE UNTIL FINAL POSITION IS LOCATED!**

\*(Partial Plate and U-Bolts Showing)

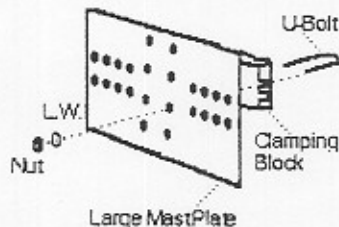
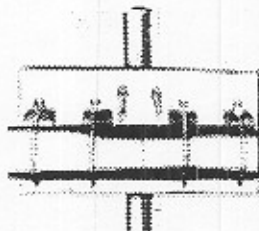

< > Place 8 #47 clamping blocks (part 30A) between the boom and the mast plate and secure with the eight 2" U-bolts, (part 24A) and secure the U-bolts with lock washers and nuts (parts 26A, 27A).

NOTE: WHEN ATTACHING ELEMENTS, MAKE SURE THE MAST PLATE AND STRUT PLATE ARE AT RIGHT ANGLES WITH THE ELEMENTS, THIS WILL KEEP THE ELEMENTS HORIZONTAL TO THE GROUND WHEN THE ANTENNA IS PLACED ON THE MAST.....

### ASSEMBLY OF PHASING LINES

< > Assembly of Phasing Lines. The two lines (part 28) are used between the Front Driven Element and the Back Driven Element. Place a 8-32 x 1" screw (part 29A) on each of the phasing lines as shown in the drawing. Attach the 8-32 screw, using a lock washer, and nut. (Parts 29A, B, C). Set aside until needed.

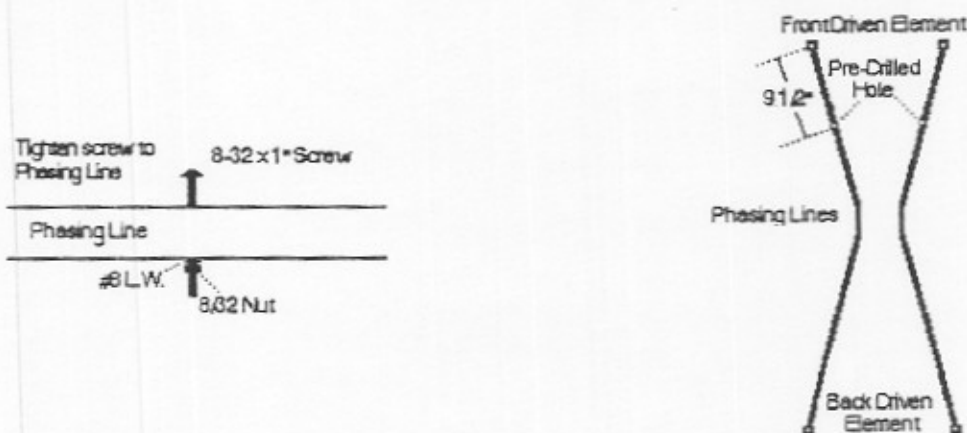

### REVIEW OF DRIVEN ELEMENTS

NOTE: There are several adjustments to the antenna. One on the DOUBLE BROWN 3/8" END TIP, which controls 40 meters. And three choices on the inner 7/8" BROWN.

The Brown 7/8" tubing has 3 choices, Code I, Code II, Code III. These settings control 10 and 15 meters. The standard is Code II. If in your initial testing 15 meters is low in frequency, move the 7/8" Brown tube to the Code III.

The 40 Director and Reflector have been pre drilled for the Code III setting which will give you from 7,133 to 7,275 at or below 1.5:1. If you change the driven element for 40 meters refer to the chart to see what length to make the 40 meter reflector. These settings should get you very close to the performance you want.

The reason we have not included several pre drilled choices, are that they will change based upon your individual installation, that is height, etc.. However, we have enclosed a chart of sample settings.

#### 40 Meter Settings

Approx.Center Freq.	(7,050)	(7,127)	(7,205)	(7,282)
	CODE I	CODE II	***CODE III	CODE IV
107.2 Reflector	43"	40"	***37"	34"
169.5 Radiator	63-3/8"	60-3/8"	***57-3/8"	54-3/8"
Director	46"	46"	***46"	46"

\*\*\*Pre-Drilled setting

An example of Code III for 40 meters: (The 1.5 to 1 end points are 7,133 and 7,275. The antenna is flat from 7,185 through 7,215).



The second area to adjust, is on the DOUBLE RED END TIP, which controls 20 meters.

If (Code I) is selected the directors (TRIPLE BLUE AND DOUBLE BLUE will need to be put in the longest setting, by using the longest of the 2 pieces of 7/8 tubing, which joins the two traps along the element. This needs to also be done to the reflector DOUBLE YELLOW.)

### 20 Meter Settings

Approx. Center Freq.	(14,117 to 14,320 1.5 ends)		(14,200)	(14,300)
	CODE I	***CODE II		
Reflector	14-7/8"	***11-3/8"		11-3/8"
Radiator	13-3/4"	***13"		12-1/4"
1st Director	34-3/8"	***31-1/8"		31-1/8"
2nd Director	14-1/4"	***12-1/4"		12-1/4"

Note: \*\*\* = Pre-Drilled setting

An example of Code II for 20 meters: (The 1.5 to 1 end points are 14,117 and 14,320. The antenna is flat from 14,180 through 14,220).

The other bands are so broad that they should cover most of your operating needs. However, if you would wish to adjust these bands it can be done very easily. Contact our engineering department at 314-994-7872, and we will be glad to advise you.

The first adjustment is made to the 40 meter radiator end tip. This the DOUBLE BROWN 3/8" end tip for the FRONT DRIVEN ELEMENT. There is 1 setting provided at 57-3/8". This pre drilled settings will only be good at the test height of 45'. However, before installing the antenna you can determine if this setting is the one you wish to use. In our testing we have found that 54-3/8" will give you high phone band; the predrilled setting (CODE III) will give you from 7,133 to 7,275 below 1:5 to 1; and that 63-3/8" will give you the CW portion of 40 meters. One of the frequency choices will put you in the area you wish to work, or you can custom this dimension at your antenna sight. Depending on your height above ground, this center frequency will vary.

In order to self adjust this element, you will need to get the antenna about 30' off of the ground. This can be on the side of your tower or at its installed position on the tower. If you adjust this element near to the ground plan for a 70 to 125 kHz movement higher in frequency when the antenna cross above the 1/4 wave height above artificial and real ground. Start by putting the 40 meter end tip in the 57-3/8" position and locate the center frequency at your installation. If the frequency is lower than you wish you will need to shorten the end tip. If it is high in frequency, you will need to lengthen it. Make your adjustments in 1" movements. Do each side equally. To temporarily hold the element in position use a piece of electrical tape until you have the frequency you wish.

To set the element drill a #30 hole 1/2" longer than the exposed area. This will take into consideration the 1/2" drill hole in the 5/8" swaged piece of tubing.

Once your center frequency is set choose a reflector length from the chart closest to your operating frequency. For example, if the center frequency you wish is 7,223 then select the CODE III length for the reflector of 37".

The second choice for adjustment is the RED back driven element 5/8" end tip. This also has one pre drilled setting, however as stated above you can adjust this element for the exact area of the band you wish to operate.

The predrilled setting covers from 14,315 to 14,091 at or below 1:5 to 1. This has been the most requested area of the band in which to configure the 20 meter section.

(For any 20 meter frequency above 14,100 use the shorter pieces of 7/8" tubing between the traps on the 2nd director and the reflector. On the 1st 20 meter director (Double Blue), use the shortest setting, which will give you 26-3/4" exposed 5/8" end tip.

If you wish to use the cw portion of the 20 meter band only then use the longest pieces between the traps and 30" exposed on the 1st 20 meter director.

This element doesn't need to be as high above ground to adjust as the 40 meter end tip since it does not couple with ground as readily. The CODE II setting on this element is centered at 14,187.

The use of a tuner on the section of the band where the SWR is too high to operate, will correct any reactance in the system.

Review the SWR chart so you can get a general idea of where you will want to position these elements. If you need any help or have any questions please give us a call at the engineering department.

### ASSEMBLY OF DRIVEN ELEMENTS

< > FDE = "forward driven element". Loosely install 8 plastic insulators (part 2) on the rectangle support plate (part 1) with lock washers and screws (parts 3,4). Place plastic caps (part 65) on the inboard end of the element sections (part 6) color coded BROWN. Place one element section into the "v" on the insulators (part 2) so that the screw hole on the outboard end is facing DOWN.. (This is necessary to assure proper position of trap assemblies which are provided with breather holes and should always face DOWN).

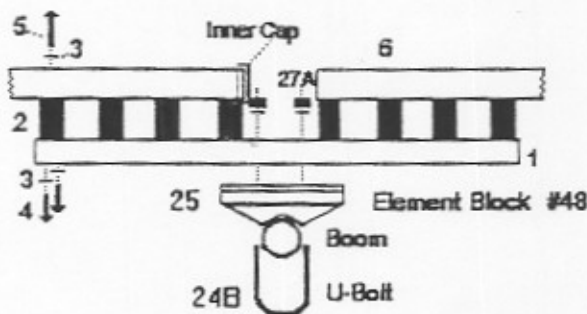

< > Insert screw (part 5) through lock washer (part 3), the small hole on one end of the phasing line through the element (part 6) and into the insulator (part 2). Insert screw (part 5) through the lock washer (part 3), element (part 6) and into the insulator (part 2). DO NOT OVER TIGHTEN SCREWS INTO INSULATOR BLOCKS....

< > Place the other element section (part 6) color coded brown over the opposite side insulators (part 2), insert screw (part 5) through lock washer (part 3), through the corresponding hole on the phasing line (part 28), the element (part 6) and into the insulator (part 2).

< > Insert screw (part 5) through lock washer (part 3), element (part 6) and into the insulator (part 2). Tighten all screws in the element supports, BUT do not over tighten screws. Tighten enough to set lock washers.

< > Continue assembly by inserting the BROWN coded end of the remaining elements and the 12" trap into the corresponding end of the next element coded BROWN. (parts 6, 6A, 7, 10, 12.) Secure elements with screw (part 8).

< > Add the remaining BROWN trap (part 14) to the exposed element with the color code in toward the boom. (This end trap is the longer of the two traps). (Make sure trap drain holes and element screw holes are pointed down to ground side.) Add the remaining end sections and choose the setting you wish for 40 meters on the last end tip section of 3/8" tubing.

< > Place 3/8" end caps on end tip element. (part 23).

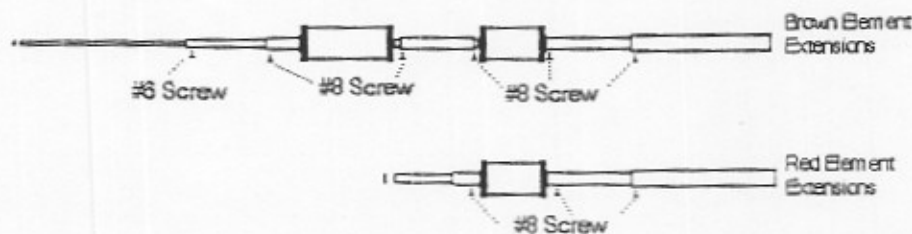

< > Insert the plastic inner 1" plug into the RED 1-1/8" tube at the open end side at the center of the element.

- < > Insert the plastic inner 7/8" plug into the BROWN 1-1/8" double wall tube at the open end side at the center of the element.

**NOTE:**

- < > If needed use a wire snip to trim the plastic plugs to clear the edge of the insulator block so that the plug will seat into the tubing.
- < > Complete opposite side of BROWN driven element. Follow the same procedure of BDE - back driven element, Color Coded RED.

### PLACING FDE/BDE ON BOOM

- < > Locate color code for the FDE on boom. Place assembled FDE over color code and insert #50 clamping block (part 25) on boom between FDE and boom. Place U-Bolt (part 248) around boom, through clamping block and element support. (part 1).

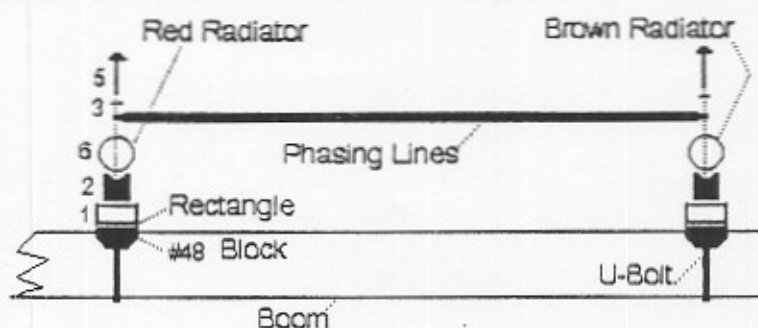

- < > Secure U-bolt with lock washers and nuts. (Parts 26A, 27A).
- < > Tighten down element to boom, but don't completely tighten until all elements are aligned and are parallel to each other on boom.
- < > Place BDE on boom in the same manner as FDE.

### PLACEMENT OF PHASING LINES ON DRIVEN ELEMENTS

- < > Note: The BEND IN THE PHASING LINES GO IN TOWARD EACH OTHER OVER THE BOOM. Lift the screws on the inner insulator blocks first on the forward driven element (Note the BROWN color on the phasing lines) and place the end of the phasing line on top of the element and secure with the lock washer and 10/32 screw.

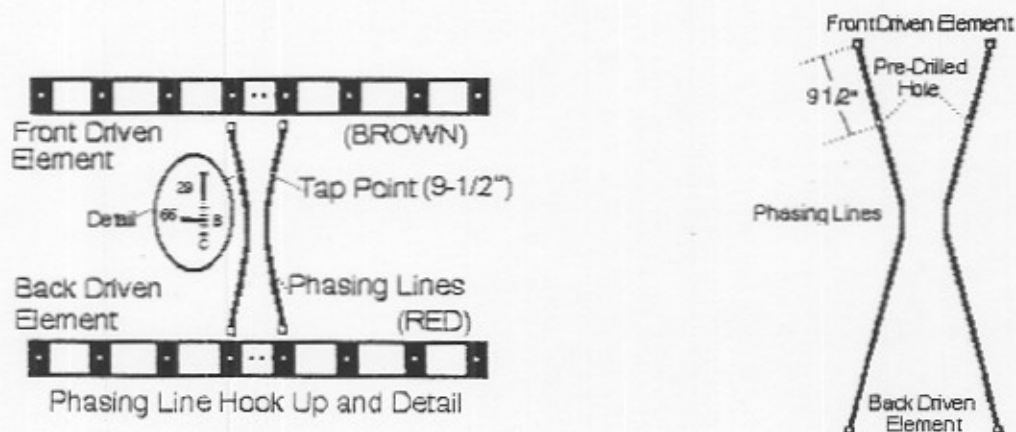

- < > Repeat this procedure to the opposite side of the FDE.

- < > Repeat this for the back driven element.
- < > Connect phasing line to BDE as was done on FDE.

### ASSEMBLY OF PARASITIC ELEMENTS

- < > Assembly of the 12/17/20/40 meter reflector.
- < > Insert a YELLOW coded element section (part 39) on each end of the center section of (part 38) and align the large holes, KEEPING end element holes for next section pointing down.

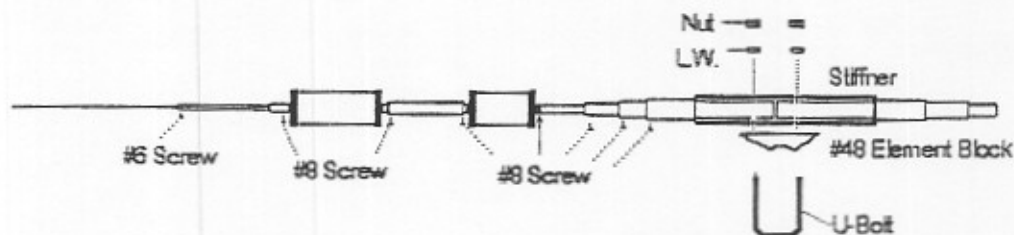

- < > Ready to use #48 clamping block and 2" U-bolt.
- < > Place #48 clamping block under center section of ELEMENT, and place U-bolt through #48 block and element center section making sure inner element sections are locked into position by U-bolt.
- < > Loosely place lock washer, and nuts on U-bolt to keep it from coming out of element.
- < > Continue inserting next size of tubing color coded yellow onto element. Secure with #8 Sheet metal screw. Continue this procedure until you have attached the 7/8" tubing prior to the 1st trap. (Parts 38 through 40B).
- < > Place Yellow color coded 12" trap onto element making sure color-coded end is pointing in toward the boom. Secure with #8 Sheet metal screw.
- < > AT THIS TIME YOU WILL CHOOSE THE 10-3/8" or 13-7/8" piece of 7/8" tubing to go between the traps.
- < > If you are going to have a center frequency above 14,100 (14,350 to 14,100) then use the shortest piece of the end of the phasing line on top of the element and secure with the lock washer and 10/32 screw.
- < > Repeat this procedure to the opposite side of the FDE.
- < > Repeat this for the back driven element.
- < > Connect phasing line to BDE as was done on FDE.

### ASSEMBLY OF TRIPLE BLUE DIRECTOR

- < > Assembly of the 10/15/20/40 meter director COLOR CODED TRIPLE BLUE.
- < > Insert a TRIPLE BLUE coded element section on each end of the center section of and align the large holes, KEEPING end element holes for next section pointing down.
- < > Ready to use #48 clamping block and 2" U-bolt.
- < > Place #48 clamping block under center section of ELEMENT, and place U-bolt through #48 block and element center section making sure inner element sections are locked into position by U-bolt.
- < > Loosely place lock washer, and nuts on U-bolt to keep it from coming out of element.

- < > Continue inserting next size of tubing following the TRIPLE BLUE color code as was done on the reflector.
- < > Place TRIPLE BLUE color coded 12" trap onto element making sure color-coded end is pointing in toward the boom. Secure with #8 Sheet metal screw.
- < > AT THIS TIME YOU WILL CHOOSE THE 11-1/4" or 13-1/4" piece of 7/8" tubing to go between the traps.
- < > If you are going to have a center frequency above 14,100 (14,350 to 14,100) then use the shortest piece of 7/8" tubing color coded triple blue.
- < > Secure tubing to the traps with the #8 screws. Also pay attention to the direction of the color code. It always goes toward the boom.
- < > Place 5/8" swaged element into exposed end of trap.
- < > Place 3/8" element into swaged 5/8 section. Secure with a #6 screw (Part 17).
- < > Place a 3/8 end cap on element end. (Part 23).
- < > Place element on color coded spot on boom. Tighten down, but remember elements might need to be aligned along boom.
- < > Repeat these same steps for the opposite side of the Triple Blue Director following the Triple Blue color code. Remember to choose the correct piece of 7/8" tubing between the traps as you did on the reflector.

#### ASSEMBLY OF SMALLER TRAPPED ELEMENTS

- < > Repeat the same procedure as used on the double trapped elements. Refer to the drawing below for the Double BLUE, Double WHITE and Triple WHITE trapped elements using the appropriate parts and color coded pieces.
- < > One the DOUBLE BLUE DIRECTOR you will need to choose the correct exposed length on the 5/8" end tips. If you are using the phone and high CW

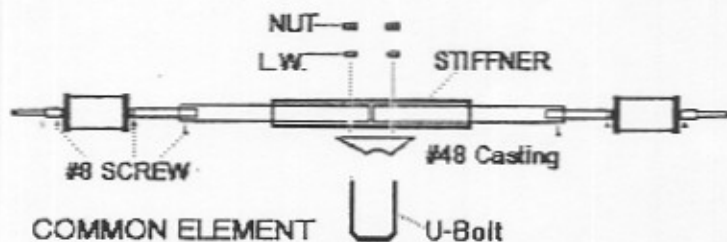

area of the band use the shortest exposed length of 26-3/4". If your operating only in the CW portion of the band then use the longest setting which will give you 30" exposed on this end tip.

#### ASSEMBLY OF MONO-PARASITIC

- < > Start with the DOUBLE BLACK coded elements.

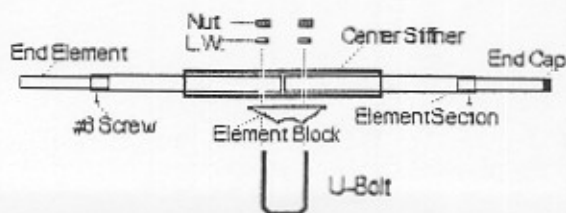

< > Place inner elements into larger stiffener (parts 47, 48, 49) making sure screw holes are to the ground side, but since these elements will be placed on inner sections of the boom, do not install the U-bolt and clamping block (parts 24B, 25, 26A, 27A) until you have the element over the color-coded portion of the boom which applies to that color coded element. COMPLETE ADDING OUTER ELEMENT SECTIONS BEFORE PLACING ON THE BOOM. This will make the assembly easier. Secure element sections with #8 sheet metal screw.

< > Continue with the remaining mono element color coded green.

< > Once all elements are on the boom, align them so that they are all parallel to each other and tighten down.

### ATTACHING VERTICAL STRUT AND SUPPORT CABLE

< > Assemble strut bracket by placing 3/8" x 3-1/2" EYEBOLT through holes in channel wings. Make sure EYELET rings are on the same side of channel surface. (Parts 60C, 60, 30A, 24A, 26A, 27A). Refer to drawing.

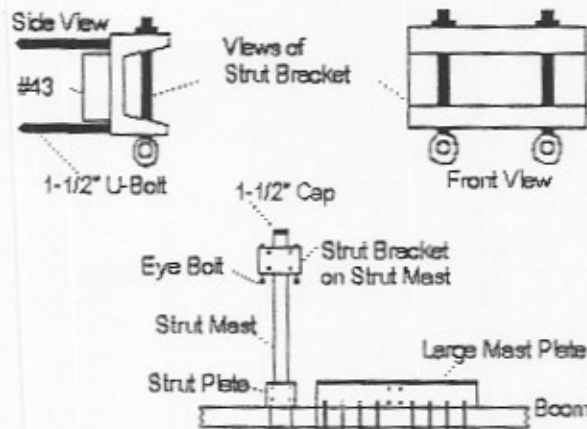

< > Attach Vertical support to STRUT PLATE already on boom. Use the 1-1/2" U-Bolts, #43 clamping blocks and hardware to secure in place.

< > Attach the Strut block to the top of the vertical support. Use the #43 clamping blocks and 1-1/2" U-bolts and hardware. MAKE sure the eyelets on the strut block are pointing downward and in line with the boom. ALSO MAKE SURE THE EYELETS ARE OVER THE BOOM, not to the away side.

< > Insert the 3/16" aircraft cable into the eyelet on the strut block. Use about a 1 foot over lap and secure with the 3/16" cable locks. Use 3 cable locks per end of cable.

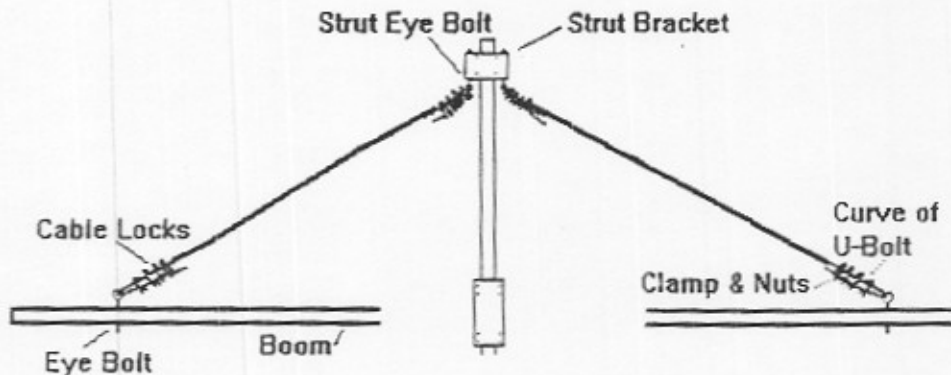

< > Repeat this for the remaining side.

- < > Repeat this for the remaining side.
- < > Re check that all bolts and hardware are tight.
- < > Attach the remaining end of cable to the eyelets on the boom. Make sure that the boom is level. Pull the cable to the point that it is just starting to support the boom, while keeping the boom level.
- < > Secure cable in place with 3/16 cable locks.
- < > Once all cable locks are in place, check to make sure boom is level.
- < > Once all hardware is re checked and the cable and boom are correct, cut any excess of cable from support.
- < > Place boom end caps on boom.
- < > This completes the assembly of the beam. Re check all connections and phasing lines. Make sure penatrox was used on all connecting pieces of tubing and traps. Also make sure trap drain holes are pointing down toward the ground or bottom side.

### PREPARING COAX

- < > Cut insulation on coax back 2-1/2" and form the braid of the coax into a leg of the line.

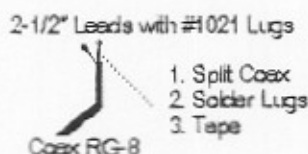

- < > Once the coax is in the form of a "Y", tape junction, (area where the coax stops and the two lines of the "Y" start), with a good 3-M type electrical tape. This will seal coax from the weather.
- < > Cut the insulation on the "HOT" or center of the coax line, back 1/4" and solder one of the #1021 solder lugs to the exposed end of the center section of the coax.
- < > Before soldering the #1021 solder lug on the braided section, twist braid to ensure you have a good section of line.
- < > Solder #1021 solder lug onto the braided line. Be careful not to over heat the braid line to avoid the melting of the insulation covering the center section of the coax..

### PLACEMENT OF COAX TO PHASING LINES

- < > Attach the coax at the drill point on the phasing lines located 9-1/2" from the center of the FRONT DRIVEN ELEMENT, Color Coded Brown.

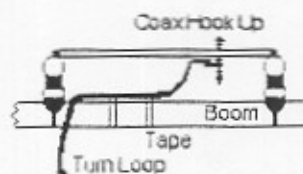
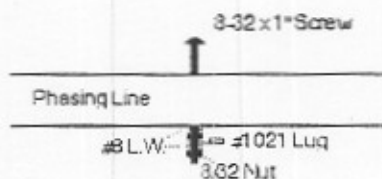

- < > Mount the #1021 solder lugs on the coax to the bottom side of the phasing lines using the 8/32 screw, lock washer, and nut. (Parts 29a, 29b, 29c).
- < > Repeat the above procedure with the braided side of the coax.
- < > Check to make sure solder lugs are secure on the phasing lines.

### USE OF RF CHOKE

- < > You may want to insert an R.F. Choke into the coax line to eliminate any RF on the coax line. To make the choke, coil the feed line (10 turns in a 10" diameter) right after the point where the coax attaches to the phasing lines. Tape the coil in three places to keep the coil in position and then tape the

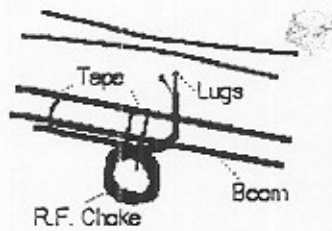

completed coil to the under side of the boom directly under the feed point on the phasing lines.



### Pro-96 Dimension Drawing

The lengths shown are for the "Factory Pre-Drilled" average frequency settings. These dimensions will change by the amount of change made according to the changes made to the individual element.

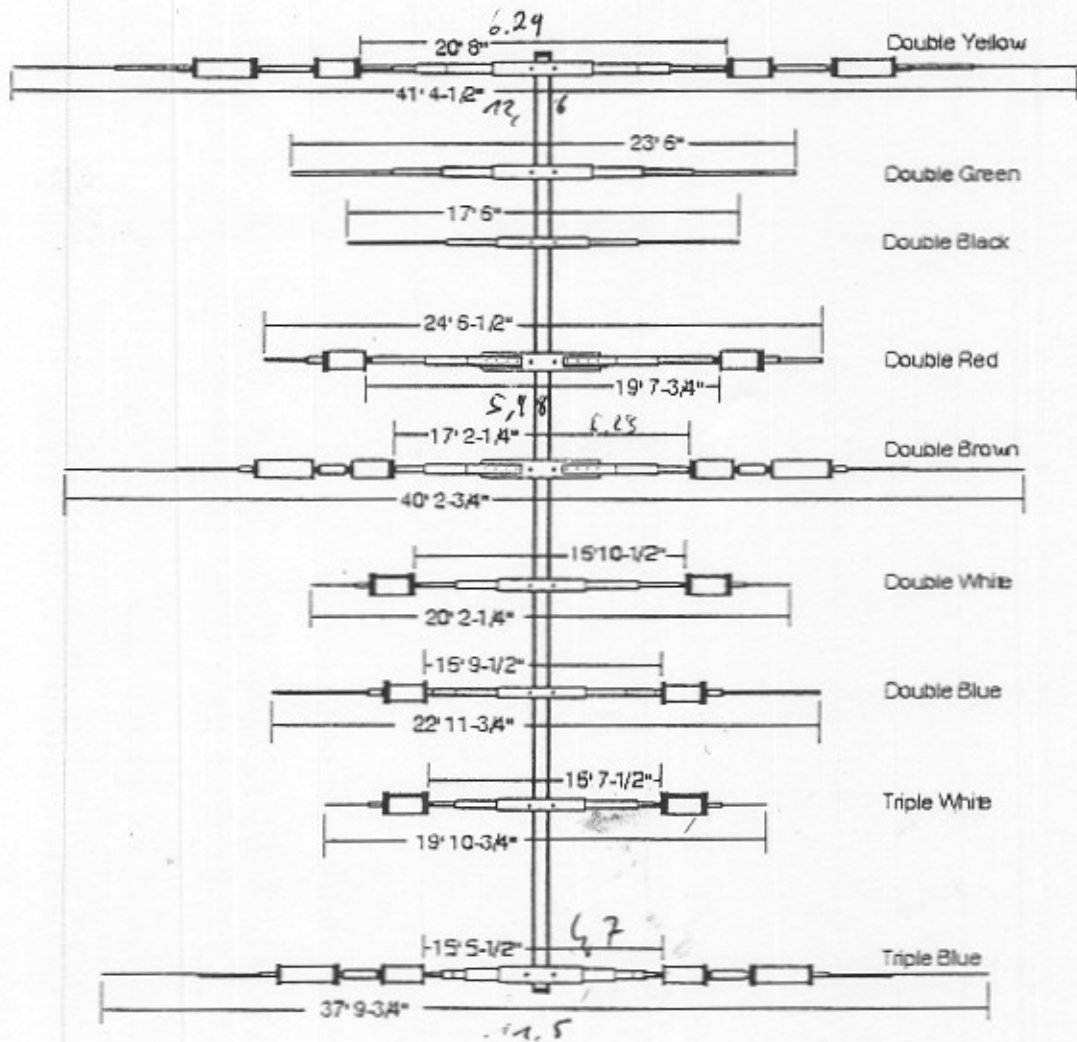

SPACING OF ELEMENTS ALONG BOOM

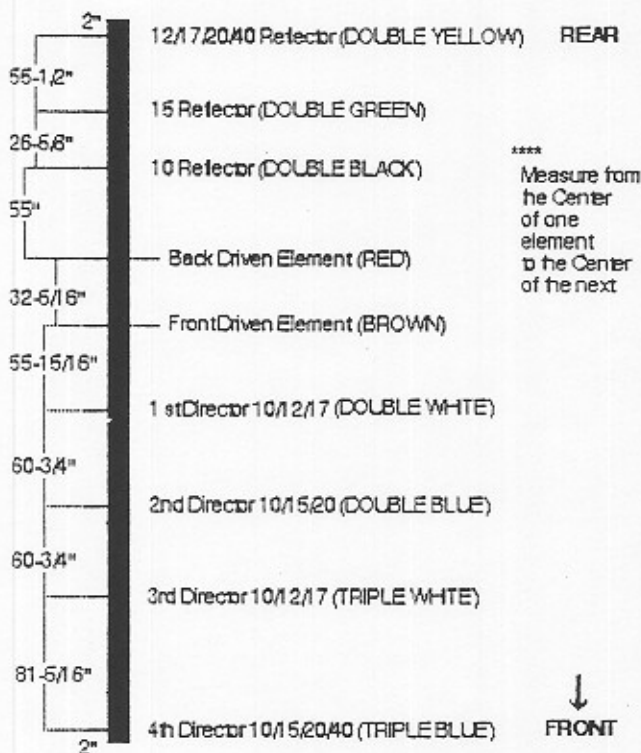

Re check ALL CONNECTIONS

- < > Make sure all hardware is tight and all color codes were followed.
- < > Make sure the penetrox was used.
- < > Place any remaining end caps or boom caps in place.
- < > Check the coax attachment points.
- < > Review the drawings.

## SUGGESTIONS

Before hauling your antenna all the way up a tower, check it at least 10 to 12 feet off the ground. In checking the antenna, DO NOT put the reflector on the ground and point the antenna up in the air. Place the antenna on a ladder, temporary pole, or to the side of your tower in the horizontal plane. This will enable you to get an over view of the antenna. That is, if you're showing 10:1 everywhere, you have a problem. However, if you are seeing the antenna trying to dip, but not going completely flat and/or the frequency is 50 to 80 kHz. lower in the band; the antenna is correctly assembled. Remember at this low height you are coupling with ground. That can be both real ground and artificial ground. Doing this simple check before final installation can save you and your crew a lot of frustration. If you think you have a problem or something is going on you don't understand, please call us at our office line 314-994-7872 and ask for engineering, we will be glad to help. We want you to be as happy as we are you chose MOSLEY and the PRO-96!

## NOTES

TYPICAL SWR CURVES FOR FACTORY SETTINGS

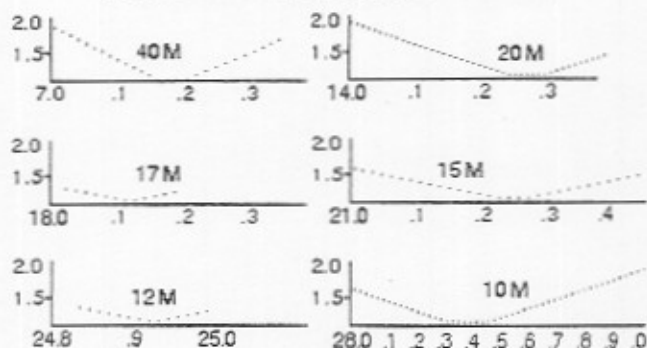

# M.E.I.

*Mosley "A Better Antenna"  
St. Louis, Missouri, U.S.A.*

---